

808nm 10W Single Diode Laser

Applications

- Medical illumination
- Target Indication
- Laser Show
- Stage Lighting



Parameters (20°C)

COS/F Package Single Laser Diode			
Parameter		Unit	LDMC-0808-010W-*5
Optical Parameter	Output power	W	10
	Lasing Wavelength	nm	808±10
	Spectral Width	nm	≤5
	Emitting Area width	μm	200
	Temperature Coefficient	nm/°C	0.30
	Fast Axis Divergence	deg	<40
	Slow Axis Divergence	deg	<10
Electrical Parameter	Slope Efficiency	W/A	≥1.00
	Threshold Current	A	≤1.80
	Operating Current	A	≤12.00
	Operating Voltage	V	<2.00
Others	Package	-	COS/F Package
	Operating Temperature	°C	15 ~ 30
	Storage Temperature	°C	-40 ~ 60



Package Information

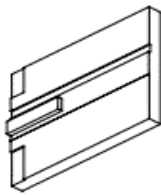
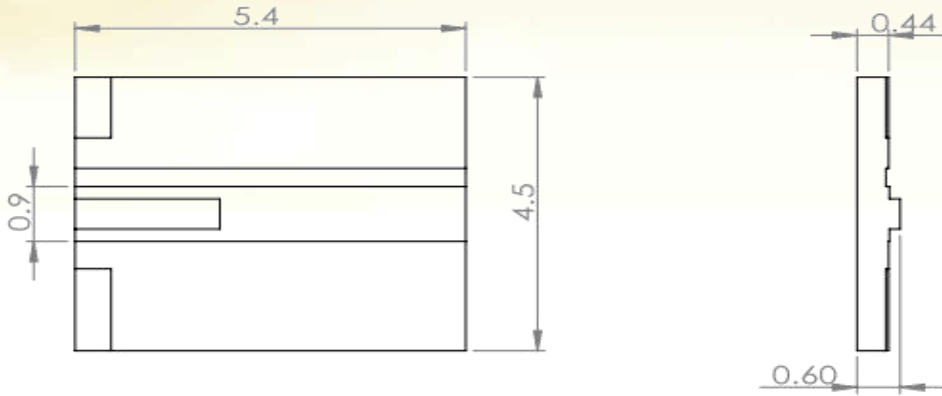

COS Package

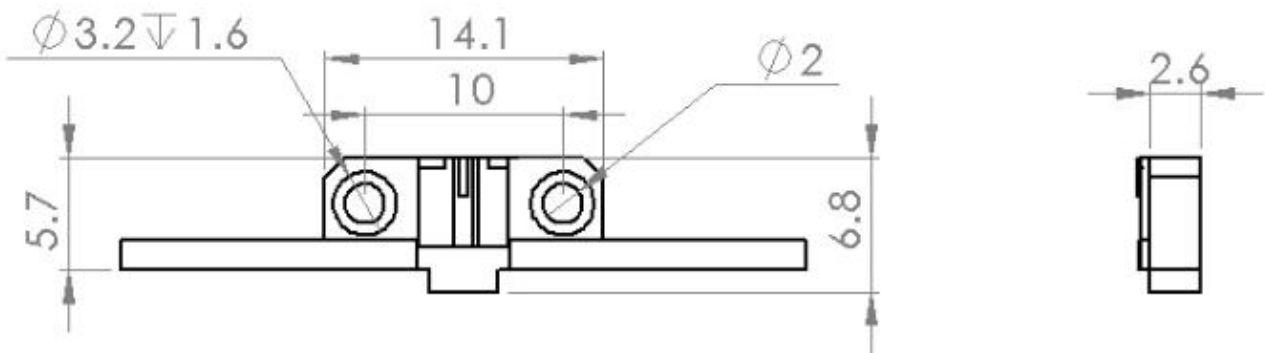

F Package





海特光电有限责任公司
Hi-Tech Optoelectronics Co.,Ltd.

Notice

1. Item model notice: LDM(Item model),****(Center wavelength),****(Output power), **(Heat sink structure and item width).
2. Data in the sheet are all basis on C-mount package heat sink testing.
3. For more information, please contact Hi-Tech Optoelectronics Co., Ltd.



Add: Shahe Industrial Park, Changping District, Beijing, China
Tel: +86-10-6076 9887 Fax: +86-10-6076 9887-699
Web: www.htoe.com.cn Email: sales@htoe.com.cn

